

OPTIMUS®

Professional Series

Digital Synthesize Audio/Video Surround Receiver STAV-3580

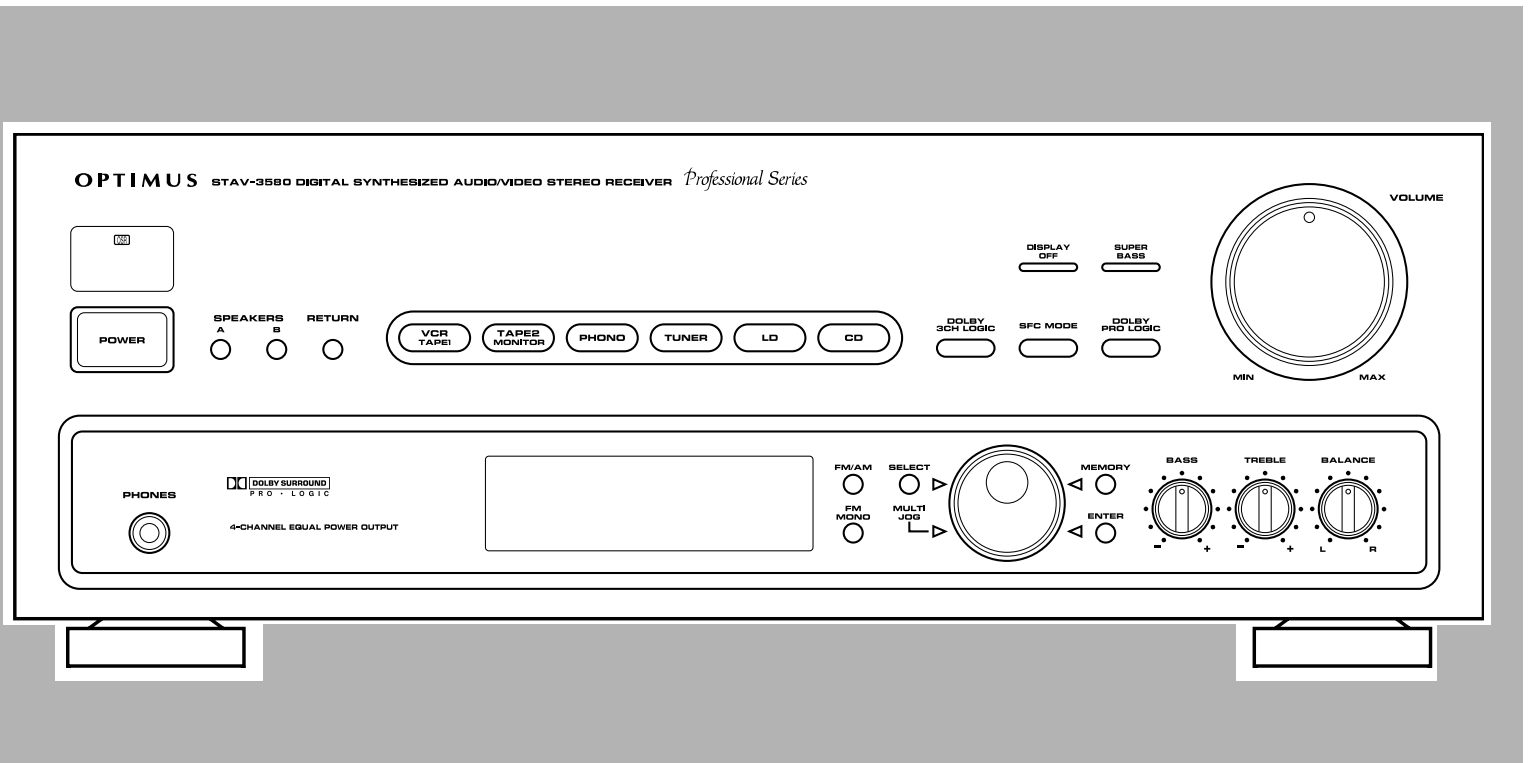

Introducing the Optimus STAV-3580

Your Optimus STAV-3580 Digital Synthesized A/V Surround Receiver is the perfect control center for your audio/video system. It combines 110 watts-per-channel of clean power with modern styling and provides connections for one tape deck, one audio/video source, one more tape deck or audio/video playback source, a turntable, a CD player, and a video monitor.

Your receiver also has special sound options. *Dolby Pro-Logic Surround Sound* delivers movie theater sound for audio/video programs (especially those encoded with Dolby Surround Sound signals). *Dolby 3CH Logic* provides a wider sound field than ordinary playback. *Studio Effect* simulates the ambiance of a recording studio, adding extra richness to your music. *Simulated Surround* gives you a surround-sound effect even when you listen to monaural sources.

Additional features include:

Digital-Synthesized Tuner Precisely tunes to AM and FM stations.

Multi-Jog Tuning Offers you a simple tuning method for either memorized stations or the entire frequency range.

Automatic Tuning Searches for the next available AM/FM station.

30 Memory Locations Let you store and recall the frequencies for up to 30 AM/FM stations.

Subwoofer Output Lets you easily connect an amplified subwoofer that delivers the very low frequency bass sounds, bringing out the richness and depth of music plus the full impact of motion-picture special effects for sound you can actually feel.

Super Bass Creates a richer, fuller sound by enhancing the audio program's bass.

Tape Monitoring Lets you listen to the actual recording as you record, if your tape deck has a tape-monitoring feature.

Built-In Protection Circuits Turn off the receiver to help avoid power surge or short circuit damage.

Remote Control Lets you use a single remote control for the receiver and other compatible components connected to the receiver.

Display Blanking Lets you turn off the display so the light does not disturb you in low-light situations.

For your records, record the receiver's serial number here. The serial number is on the receiver's back panel.

Serial Number: _____

Note to the Cable TV System Installer:

This reminder is provided to call the CATV system installer's attention to article 820-40 of the National Electrical Code that provides guidelines for proper grounding and, in particular, specifies that the cable ground shall be connected to the grounding system of the building as close to the point of cable entry as practical.

Manufactured under license from Dolby Laboratories Licensing Corporation.

Additionally licensed under one or more of the following Patents: U.S. Number 3,959,590; Canadian Numbers 1,004,603 and 1,037,877.

Dolby, Pro Logic, and the double-D  symbol are trademarks of Dolby Laboratories Licensing Corporation.

© 1996 Tandy Corporation.

All Rights Reserved.

Optimus is a registered trademark used by Tandy Corporation.

RadioShack is a trademark used by Tandy Corporation.

IMPORTANT SAFETY INSTRUCTIONS

This receiver is made and tested to meet exacting safety standards. It meets both UL and FCC requirements.

WARNING: TO REDUCE THE RISK OF FIRE OR ELECTRIC SHOCK, DO NOT EXPOSE THIS APPLIANCE TO RAIN OR MOISTURE.

To prevent fire or shock hazard, do not expose this system to rain or moisture.

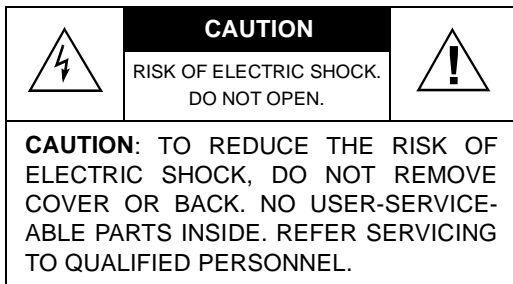

This symbol is intended to alert you to the presence of uninsulated dangerous voltage within the system's enclosure that might be of sufficient magnitude to constitute a risk of electric shock. Do not open the system's case.



This symbol is intended to inform you that important operating and maintenance instructions are included in the literature accompanying this system.

CAUTION

Power Lines—Locate an outdoor antenna away from power lines.

Nonuse Periods—Unplug the receiver's power cord when you will not use it for extended periods.

Outdoor Antenna Grounding—If an outside antenna or cable system is connected to the receiver, ground the antenna or cable system so as to provide some protection against voltage surges and built-up static charges. Article 810 of the National Electrical Code, ANSI/NFPA 80, provides information about proper grounding of the mast and supporting structure, grounding of the lead-in wire to an antenna discharge unit, size of grounding conductors, location of antenna-discharge unit, connection to grounding electrodes, and requirements for the grounding electrode. See the example below.

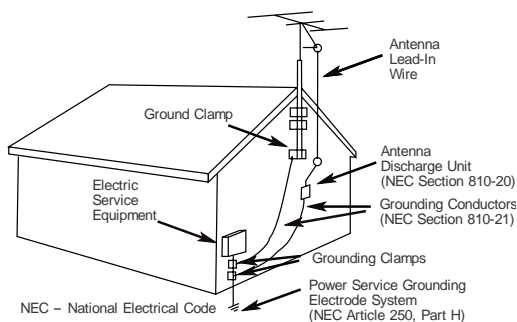

Careful attention is devoted to quality standards in the manufacture of your receiver, and safety is a major factor in its design. However, safety is also your responsibility.

This section lists important information that will help you properly use and enjoy your receiver and accessories. Read all the included safety and operating instructions before using your receiver. Follow them closely, and retain them for future reference.

Heed Warnings — Follow all warnings on the product and in the operating instructions.

Cleaning — Unplug this product from the wall outlet before cleaning. Use only a damp cloth for cleaning. Do not use liquid or aerosol cleaners.

Attachments — Do not use attachments/accessories not recommended by the product manufacturer, as they might create a hazard.

Water and Moisture — Do not use this product near water (for example, near a bathtub, washbowl, kitchen sink, or laundry tub; in a wet basement; or near a swimming pool).

Accessories — Do not place this product on an unstable cart, stand, tripod, bracket, or table. The product may fall, causing serious injury to a child or adult, and serious damage to the product. Use only with a cart, stand, tripod, bracket, or table recommended by the manufacturer or sold with the product. Follow the manufacturer's instructions for mounting, and use a recommended mounting accessory.



Carts — Move the product on a cart carefully. Quick stops, excessive force, and uneven surfaces may cause the product/cart to overturn.

Ventilation — Slots and openings in the cabinet provide ventilation, ensure reliable operation, and protect from overheating. Do not block or cover these openings, and do not place the product on a bed, sofa, rug, or other similar surface. Do not place the product in a built-in bookcase or rack unless it provides proper ventilation as specified by the manufacturer.

Power Sources — Operate this product using only the power source indicated on its marking label. If you are not sure of your home's power type, consult your product dealer or local power company.

Polarization — This product is equipped with a polarized AC line plug (a plug having one blade wider than the other). This plug will fit in the power outlet only one way. This is a safety feature. If you cannot insert the plug fully into the outlet, try reversing the plug. If the plug still doesn't fit, contact your electrician to replace your obsolete outlet. Do not defeat the safety purpose of the polarized plug. If you need an extension, use a polarized cord.

Power-Cord Protection — Route power-supply cords so they are not likely to be walked on or pinched by items placed on or against them, paying particular attention to cords at plugs, convenience receptacles, and the point where they exit from the product.

Lightning — For added protection for this product during a lightning storm, or when it is left unattended and unused for long periods of time, unplug it from the wall outlet and disconnect the antenna or cable system. This will prevent damage to the product due to lightning and power-line surges.

Overloading — Do not overload wall outlets, extension cords, or integral convenience receptacles, as this can result in a risk of fire or electric shock.

Objects and Liquids — Never push objects of any kind into this product through openings, as they may touch dangerous voltage points or short out parts that could result in a fire or electric shock. Never spill liquid of any kind on the product.

Servicing — Do not attempt to service this product yourself, as opening or removing covers may expose you to dangerous voltage or other hazards. Refer all servicing to qualified service personnel.

Damage Requiring Service — Unplug this product from the wall outlet and refer servicing to qualified service personnel under the following conditions:

- When the power-supply cord or plug is damaged.
- If liquid has been spilled or objects have fallen into the product.
- If the product has been exposed to rain or water.
- If the product does not operate normally by following the operating instructions. Adjust only those controls that are covered by the operating instructions, as an improper adjustment of other controls may result in damage and will often require extensive work by a qualified technician to restore the product to normal operation.
- If the product has been dropped or damaged in any way.
- When the product exhibits a distinct change in performance.

Replacement Parts — When replacement parts are required, be sure the service technician uses replacement parts specified by the manufacturer or having the same characteristics as the original part. Unauthorized substitutions may result in fire, electric shock, or other hazards.

Safety Check — Upon completion of service or repairs to this product, ask the service technician to perform safety checks to determine that the product is in proper operating condition.

Wall or Ceiling Mount — The product should be mounted to a wall or ceiling only as recommended by the manufacturer.

Heat — The product should be situated away from heat sources such as radiators, heat registers, stoves, or other products (including amplifiers) that produce heat.

Contents

Preparing Your Receiver	5
Positioning Speakers	5
Connecting Speakers	6
Connecting Program Sources	8
Connecting the Antennas	10
Using One Remote Control for More than One Unit	12
Installing the Remote Control's Batteries	12
Using the AC Power Outlet	13
Connecting to AC Power	13
Demonstration Display	13
Basic Operation	14
Balance Control	15
Muting the Receiver	15
Using Headphones	15
Tuning the Radio	16
Using FM Mono	17
Turning Off the Display	17
Using Sleep (Remote Control Only)	17
Cassette Deck/VCR Features	18
Using the VCR/TAPE 1 Button	18
Using the TAPE 2 MONITOR Button	18
Recording a Program Source	18
Dubbing a Cassette Tape	18
Playing and Recording Video Tapes	19
Using Advanced Sound Options	20
Sound Mode Adjustments (Remote Control Only)	21
Using the Remote Control	22
Troubleshooting	25
Returning Controls to Factory Defaults	25
Care and Maintenance	26
The FCC Wants You to Know	27
Specifications	28
Index to Features by Control Name	30

Preparing Your Receiver

Caution: Make all the necessary connections before you plug in or turn on the receiver.

Positioning Speakers

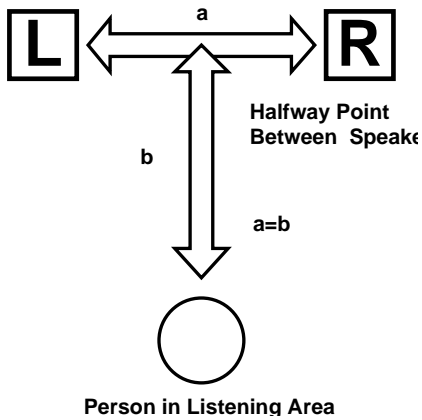

- Surround speakers generally sound best if you position them above ear level.
- To avoid interference with the picture on a nearby TV, use magnetically shielded speaker systems. This is particularly important for the center speaker since it is usually located closest to the TV.

Where you place your speakers (not supplied) can make a noticeable difference in your system's sound. The guidelines in this section will help you choose the best locations. After you use your receiver for a while, you might want to try different locations for your speakers.

Bass response depends largely on speaker location. For strong bass, place the speakers in the corners of the room. If you want even stronger bass, place the speakers directly on the floor. If the bass is too strong, move the speakers slightly away from the corners of the room, or raise them 6 to 18 inches off the floor. You can buy speaker stands at your local RadioShack store.

The distance between the speakers should be about the same as the distance between the normal listening point and the point halfway between the speakers. If you place the speakers too close together, you reduce the stereo separation. If you place them too far apart, you reduce the bass effect and create a *hole* in the middle of the sound.

Most speakers have a tweeter dispersion angle of about 60 degrees. Ideally, your listening position should be just inside the overlap area of the tweeter dispersion. You can angle the speakers toward you for better stereo effect.

To position your speakers for surround sound, place the A or B speakers at the front of your listening area, and place the surround speakers behind or to the sides of the listening point (see "Using Advanced Sound Options" on Page 20). Also, place the center speaker above, below, or behind the TV. Sound might not appear to coincide with the picture if you place it beside the TV.

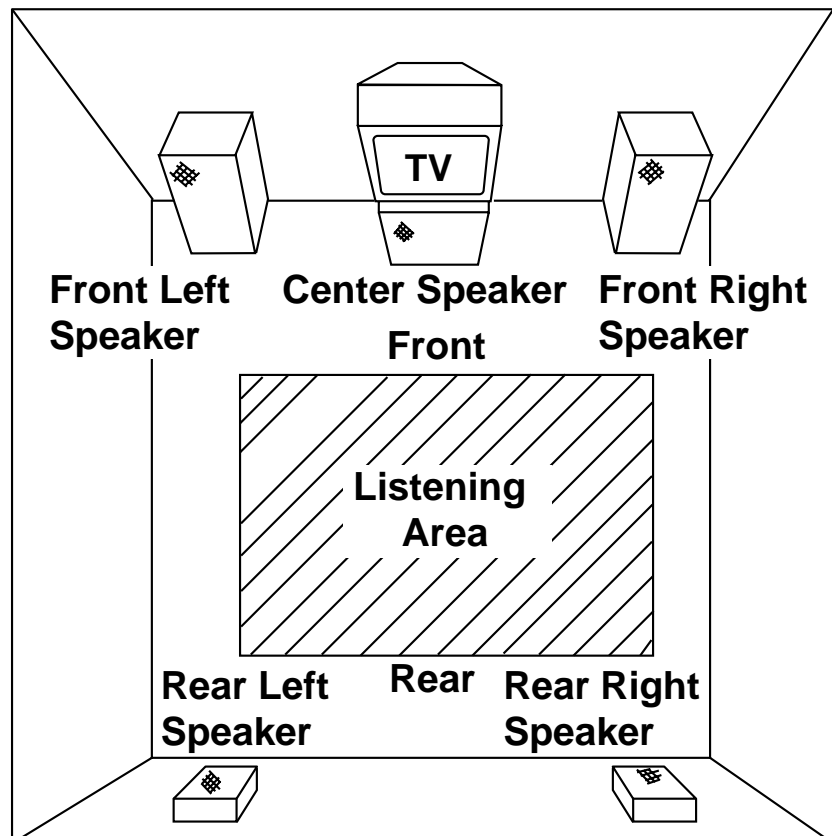

Connecting Speakers

Follow these guidelines when you select and connect speakers.

- Be sure you properly connect all speakers.
- Do not connect two pairs of speakers to a single set of terminals (A or B) at the same time. When you use two pairs of speakers, connect one set to **Speakers A** and one set to **Speakers B**.
- Optimus and other high-quality speakers have color-coded speaker terminals (red for positive polarity and black for negative polarity). Use these color-coded terminals as a guide to help you properly connect the speakers to the receiver.
- Use 16-gauge (or larger) speaker wire for all speaker connections, and consider possible speaker locations before you decide how much speaker wire you need.

Preparing the Speaker Wires

Speaker wire consists of two conductors (individual wires) encased in insulation and is usually color-coded or marked with a ridge along one side so you can identify each conductor. Use these markings as a guide to help you properly connect the speakers to your receiver.

Follow these steps to prepare the speaker wires.

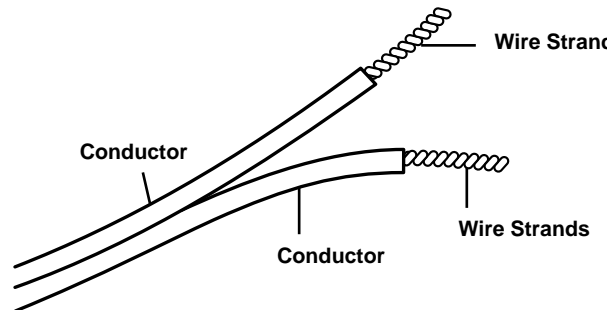

1. Cut the speaker wires to the necessary length.
2. Separate the wires about 4 inches on each end.
3. Using a wire stripper, carefully strip about $\frac{3}{4}$ inch of insulation from the end of each conductor.
4. Twist the end of each conductor to secure any loose wire strands.

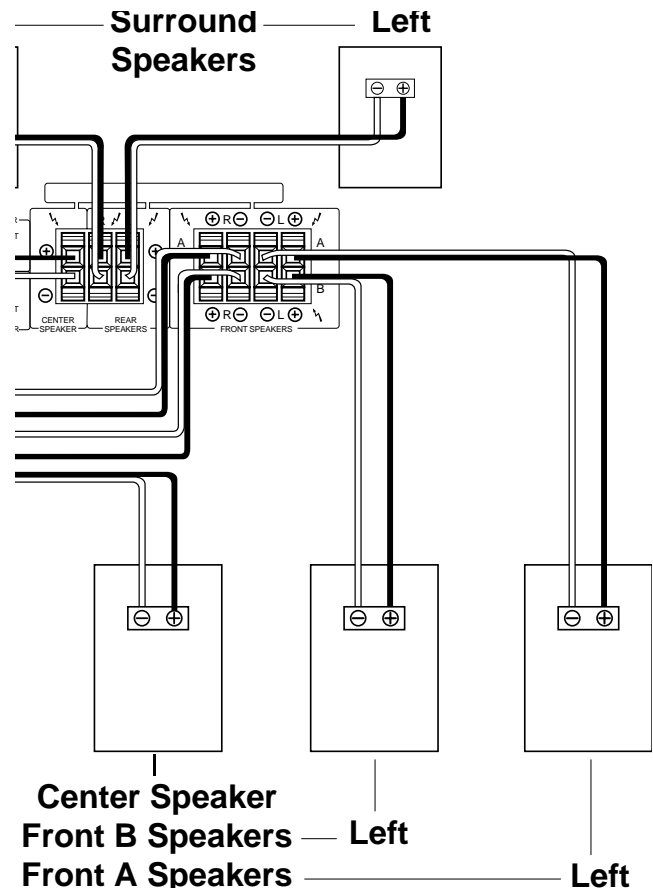

Note: Be sure you connect the receiver's right and left positive (+) and negative (–) terminals to the speaker's corresponding right and left positive (+) and negative (–) terminals.

Connecting the A and B Speakers

Follow these steps to connect the right speaker to the receiver's right **FRONT SPEAKERS A** terminals.

1. Press the receiver's **FRONT SPEAKERS A R (+)** red lever and insert the ridged or color-coded conductor's end into the small hole. Pull back the lever to secure the conductor.

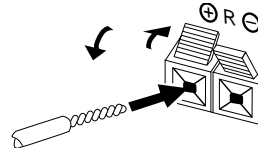

2. Press the receiver's **FRONT SPEAKERS A R (–)** black lever and insert the other conductor's end into the small hole. Pull back the lever to secure the conductor.
3. Connect the ridged or color-coded conductor's loose end to the right speaker's positive (+) terminal.
4. Connect the remaining loose conductor to the right speaker's negative (–) terminal.

Repeat Steps 1 through 4 to connect the left speaker to the receiver's left **FRONT SPEAKERS A** terminals.

Repeat this entire process to connect a second pair of speakers to the **FRONT SPEAKERS B** terminals.

Connecting Surround-Sound Speakers

You can connect a pair of speakers to the receiver's **REAR SPEAKERS** terminals for surround-sound programs. Follow the steps in "Connecting the A and B Speakers."

Connecting the Center Speaker

The center speaker gives additional ambience to surround sound. Connect the center speaker to the **CENTER SPEAKER** terminals. Follow the steps in "Connecting the A and B Speakers."

Connecting Center Channel and Subwoofer Amplifiers

To increase the center channel's output power, you can connect an amplifier to the **CENTER** jack. Then connect the center channel speaker to the amplifier.

Your receiver includes a line-level subwoofer output. Connecting a subwoofer to your system dramatically extends bass response for incredible richness and depth. When you listen to surround-sound programs, a subwoofer enhances your home theater experience by realistically recreating the rumble of an earthquake, the bone-jarring percussion of a cannon, and more.

To use this output, simply connect it to an amplified subwoofer's line-level input or to an amplifier to which you have connected a subwoofer.

RadioShack stores sell a variety of suitable subwoofers and amplifiers.

Preparing Your Receiver

Connecting Program Sources

You can connect up to five external program sources to your receiver.

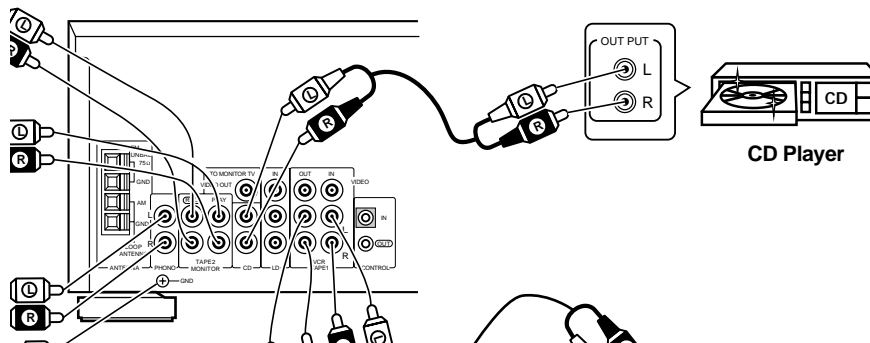

Connecting a Turntable

Connect a turntable with a magnetic cartridge only. Some older turntables use a ceramic-type cartridge that does not work with this system.

Connect the turntable's left and right cables to the receiver's left and right **PHONO** jacks. Then connect the turntable's ground wire to the receiver's **GND** terminal.

Connecting Cassette Deck(s)

You can connect cassette decks to the **VCR/TAPE 1** and the **TAPE 2 MONITOR** jacks. Connect the cassette deck's output jacks to the **VCR/TAPE 1 IN** (audio) or **TAPE 2 PLAY** jacks, and connect the input jacks of your cassette deck to **VCR/TAPE 1 OUT** (audio) or **TAPE 2 REC** jacks.

You can connect a third cassette deck (for playback only) to the **LD IN** (audio) jacks.

Connecting a CD Player

To connect a CD player to the receiver, connect the CD player's left and right output jacks to the receiver's **L** and **R CD** input jacks.

Use shielded audio cables with phono connectors for all audio connections.

Note: *If you place the cassette deck directly above, below, or to the left of the receiver, the receiver could interfere with the cassette deck's operation. If possible, position the cassette deck to the right of the receiver or locate it away from the receiver.*

Connecting Video Sources

Note: If your VCR is monaural, use a Y-adaptor (available at your local RadioShack store) to connect the VCR's audio output to both the L and R audio inputs on the receiver.

If you connect two video sources such as VCRs or laser disc players to your receiver, you can use the receiver to switch between viewing the sources. You can also use the receiver to easily record from the video sources to the source connected to **VCR/TAPE 1**.

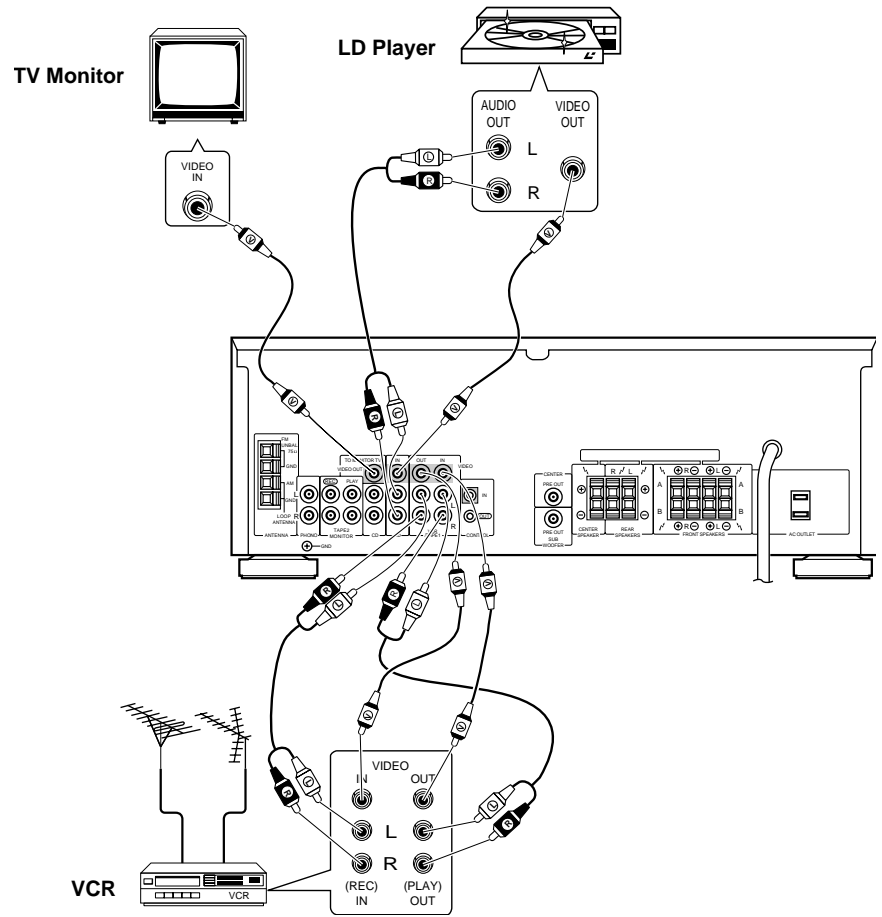

Connect phono cables from a VCR's audio outputs to the receiver's **VCR/TAPE 1** or **LD IN** (audio) jacks. Then connect phono cables from the receiver's **VCR/TAPE 1 OUT** (audio) jacks to the VCR's audio input jacks.

Connect video cables from each video source's video outputs to the receiver's **VCR/TAPE 1** or **LD VIDEO IN** jacks. Then connect video cables from the receiver's **VCR/TAPE 1 VIDEO OUT** jack to the VCR's video input.

Connecting a Video Monitor

The monitor (or TV with baseband video input) you connect to the **VIDEO OUT** terminal can monitor any source you connect to the receiver's **VCR/TAPE 1** or **LD** input jacks. Connect a video cable from the receiver's **VIDEO OUT TO MONITOR TV** jack to the monitor's video input.

Preparing Your Receiver

Connecting the Antennas

In many cities, the supplied indoor AM loop and FM antennas provide adequate reception.

AM Antennas

Assemble the included antenna's base by swinging the base in the direction of the arrow and inserting the antenna's bottom tabs into the base's slot. Then attach the antenna wires to the **AM** and **GND** terminals (bottom two terminals).

Place the antenna on a flat surface and rotate it for the best AM reception.

If the receiver is in a rack or on a shelf and there is no room for the AM loop antenna, use two screws (not supplied) to mount the base on the wall or another location as shown.

Notes:

- Keep the AM loop antenna connected even when you use another indoor antenna or an outdoor AM antenna.
- Ensure the antenna does not touch the receiver or other metal objects.
- Do not place the antenna near a CD player, a personal computer, or a TV set.
- If the wire between your AM loop antenna and receiver is too short, you can add extra wire, available at your local RadioShack store.

You can also use a RadioShack shortwave antenna kit (Cat. No. 278-758), which makes an excellent outdoor AM antenna. Connect the outdoor AM antenna wire to the receiver's AM terminal, as shown.

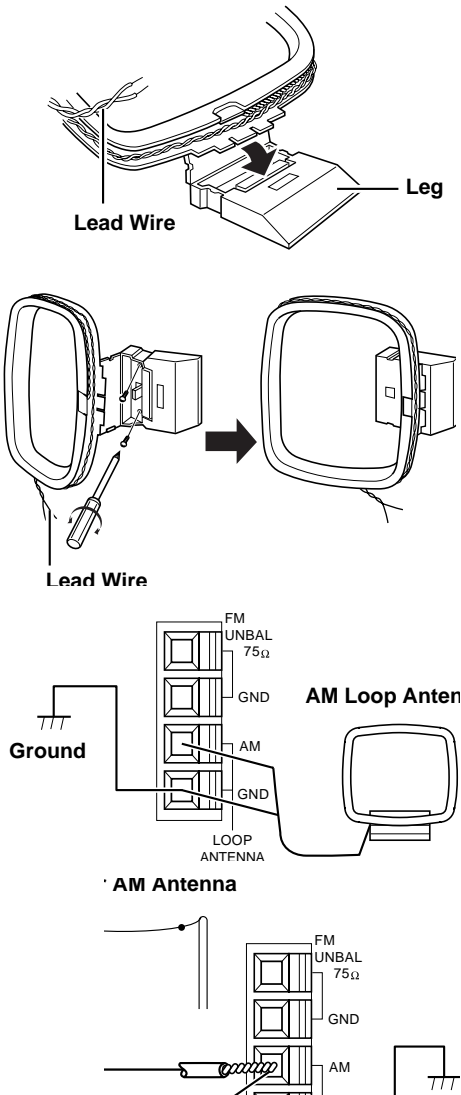

FM Antennas

Connect the supplied FM antenna to the **FM UNBAL 75Ω** terminal and extend it as shown.

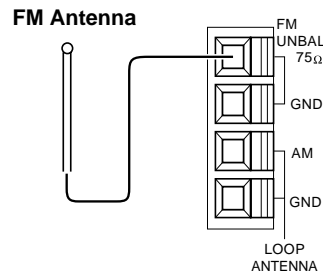

For better FM reception, you can also use a rabbit-ear TV antenna (for indoor use only) or an outdoor VHF TV antenna. To connect the TV antenna to the receiver, you need a VHF/UHF/FM splitter (not included). RadioShack stores carry a full line of quality outdoor antennas and antenna connection accessories.

Note: For the best results, use 75-ohm coaxial cable to connect an outdoor antenna to the receiver.

Warning: To prevent injury, read and follow all cautions and warnings that accompany the outdoor antenna.

For the best radio reception, use an outdoor antenna. Follow these steps to connect an outdoor FM antenna to the receiver using 75Ω cable.

Note: If your antenna has 300Ω twin-lead cable, consult your local RadioShack store for the correct adapter.

1. Disconnect the supplied FM antenna from the receiver's **FM UNBAL 75Ω** terminal.
2. With a stripping tool, remove about 1½ inches of the cable's outer insulation to expose the cable's shielding.
3. Fold back the insulation from the inner insulation.
4. Remove about 1 inch of the inner insulation from around the center wire.

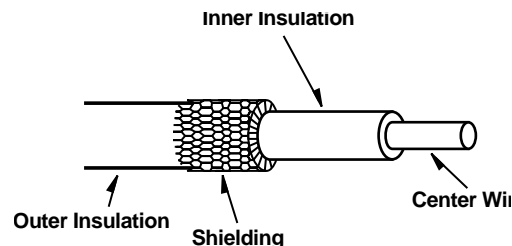

Caution: The cable's shielding should only touch the **GND** terminal.

5. Pull the shielding to one side. Connect the center wire to the receiver's **FM UNBAL 75Ω** terminal. Twist the shielding to secure any loose wire strands, and connect it to the **GND** terminal.

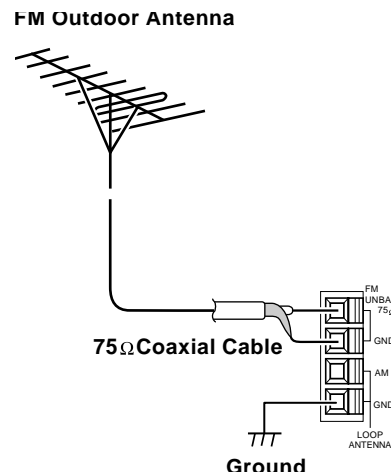

Note: Grounding is not necessary for reception, but we recommend it to avoid damage from lightning when you use an outdoor FM antenna and for better FM reception. Use a separate piece of thick polyvinyl insulated wire to connect the **GND** terminal to an earth ground such as a metal cold-water pipe.

Warning: Never connect a wire to a gas pipe for grounding since sparks might ignite the gas.

Preparing Your Receiver

Using One Remote Control for More than One Unit

Note: When you plug the cable into a component's **CONTROL IN** jack, that component's remote sensor does not function.

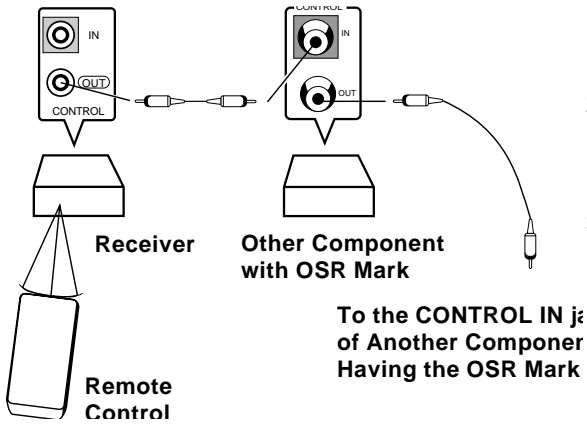

If you also have an Optimus professional series CD player, VCR, or cassette deck with the OSR mark, you can connect its **CONTROL IN** jack to the receiver so you can control all of your equipment with a single remote control. You can also use the other component's remote control by pointing it at the receiver's front panel.

1. Connect each component to the receiver as shown in "Connecting Program Sources" on Page 8.

Note: You must connect the audio cables between the receiver and the other audio accessory to use your receiver's remote control to control the accessory.

2. Connect the cable supplied with the CD player, VCR, or cassette deck between the receiver's **CONTROL OUT** jack and the other component's **CONTROL IN** jack.
3. When you want to control more than one other component using the receiver's remote control, daisy-chain the **CONTROL OUT** and **CONTROL IN** connections as shown.

Installing the Remote Control's Batteries

The remote control uses two AA batteries (not included). For the longest battery life, we recommend RadioShack's alkaline batteries (Cat. No. 23-557).

1. Press and open the battery compartment cover.

2. Place two fresh AA batteries in the compartment as indicated by the polarity symbols (+ and -) marked in the compartment.

3. Replace the battery compartment cover.

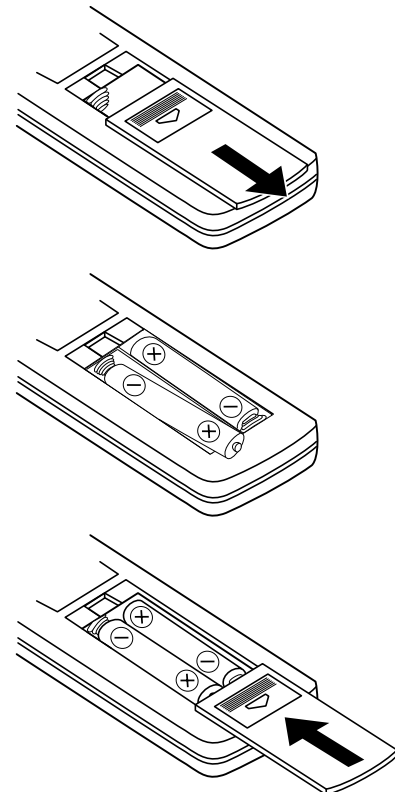

Cautions:

- Use only fresh batteries of the recommended size and type.
- Always remove old or weak batteries. Batteries can leak chemicals that can damage electronic circuits.

Note: If the remote's range is reduced, replace the batteries immediately.

Using the AC Power Outlet

Caution: Do not connect appliances with high power consumption, such as a heater, iron, monitor, or TV, to this AC outlet. Doing so can cause a risk of overheating and fire, and could damage the receiver.

Your receiver has an AC power outlet that you can use to power an electronic device, such as a turntable, cassette deck, VCR, and so on. This switched outlet turns on and off with the receiver and provides a maximum of 100 Watts.

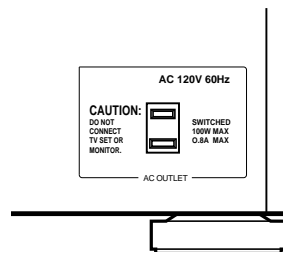

Connecting to AC Power

Warning: To prevent electric shock, do not use this polarized plug with an extension cord, receptacle, or other outlet unless you can fully insert the blades to prevent blade exposure.

Before you plug in the receiver's power cord, double check all other connections.

To power the receiver, plug the supplied power cord into a standard AC outlet. The power cord's plug is polarized and fits only one way.

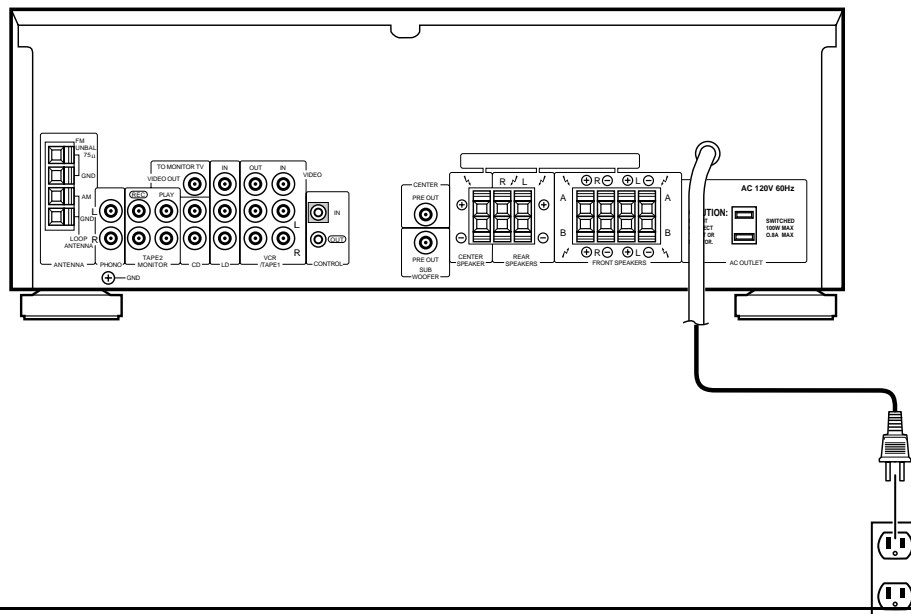

Demonstration Display

To see a demonstration of the receiver's display, press and hold **RETURN** while turning on power. The receiver cycles through several demonstration displays. To exit the demonstration mode, press any key.

Basic Operation

Warning: To prevent possible hearing loss, turn **VOLUME** to **MIN** before you turn on the receiver or change the program sources. After you turn on the receiver or change the program source, adjust **VOLUME** to a comfortable listening level.

Note: If you want to find out what a particular button or control is used for, see Page 22 (for the remote control) or Page 30 (for the front panel) to find the page where the button or control is described.

Note: If you select a source while **TAPE 2 MONITOR** is engaged, **TAPE 2** flashes five times on the display, reminding you to disengage the **TAPE 2 MONITOR** function.

Note: The controls on the remote control work the same as the buttons on the receiver's front panel.

Follow these steps to use the receiver.

1. Press **POWER** to turn on the receiver's power. It takes about 5 seconds to begin hearing sound.
2. Select the speakers.

If you connected speakers only to the FRONT SPEAKERS A (or B) terminals, press **SPEAKERS A** (or **B**) to turn on only those speakers.

If you connected speakers to both the FRONT SPEAKERS A and B terminals, do any of the following:

- Press in **SPEAKERS A** or **B** to turn on either pair of speakers for a two-speaker stereo effect.
 - Press in **SPEAKERS A** and **B** to turn on both pairs of speakers for a four-speaker stereo effect.
 - Press **SPEAKERS A** and **B** to the *out* position to silence all speakers and listen privately with headphones.
3. Select a program source.

To tune to a radio station, see "Tuning the Radio" on Page 16.

To listen to signals from the component connected to TAPE 2 MONITOR, press **TAPE 2 MONITOR** so **TAPE 2** appears on the display.

To listen to a source other than one connected to TAPE 2 MONITOR, be sure **TAPE 2** does not show on the display. If necessary, press **TAPE 2 MONITOR** so **TAPE 2** disappears.

Then press **VCR/TAPE 1**, **LD** (laser disc), **CD**, **TUNER**, **PHONO**, or repeatedly press **FUNCTION** on the remote control to display the desired program source.

4. Adjust **VOLUME** clockwise to increase the volume and counterclockwise to decrease it. Or, you can use **MASTER VOLUME -/+** on the remote control.
5. Use the **BASS** and **TREBLE** controls to adjust the program's tonal quality.
To enhance the bass level, press **SUPER BASS**.
6. Adjust **BALANCE** to suit your listening preferences. See "Balance Control" on Page 15.
7. Press **POWER** to turn off the receiver.

Balance Control

The **BALANCE** control lets you adjust the sound balance between the left and right speakers. If you properly position the speakers and your listening area is centered between them, the center control setting is usually best (see “Positioning Speakers” on Page 5).

For an unusual speaker placement, adjust **BALANCE** as follows:

1. Select **TUNER**. Then press **FM/AM** to select the FM band.
2. Press **FM MONO** until **MONO** appears. The sound is monaural instead of stereo, so each speaker delivers the same output.
3. Turn **BALANCE** until you hear the sound coming equally from each speaker when you are in the listening area.
4. Press **FM MONO** until **MONO** disappears from the display.

Muting the Receiver

To temporarily mute the sound, press **MUTING** on the remote control. **MUTING** appears. Press **MUTING** again to restore the audio level.

Using Headphones

To listen with headphones (not supplied), insert the headphones' 1/4-inch plug into the receiver's front panel **PHONES** jack. To silence the speakers, set **A** and **B SPEAKERS** to the out position and turn off any special sound options.

Listening Safely

To protect your hearing, note the following when using headphones.

- Set the volume to its lowest setting before you begin listening. After you begin listening, adjust volume to a comfortable level.
- Do not listen at extremely high volume levels. Extended high-volume listening can lead to permanent hearing loss.
- Once you set the volume, do not increase it. Over time, your ears adapt to the volume level, so a volume level that does not cause discomfort might still damage your hearing.

Tuning the Radio

Your receiver offers three types of electronic tuning—manual, automatic, and memory.

Manual and Automatic Tuning

Follow these steps to manually or automatically tune to the stations.

1. Press **TUNER**. Then press **FM/AM** to select the desired band.

When you select the AM or FM radio band, the receiver tunes to and displays the frequency last selected in that band.

2. Press **SELECT** so **FREQ** appears on the **JOG MODE** display.
3. To manually tune the station, turn the multi-jog control or repeatedly press **TUNING +** or **-** on the remote control to tune the desired station.

To automatically tune to the next higher or lower station, set **AUDIO/VCR** on the remote control to **AUDIO**. Then press and hold **TUNING +** or **-** on the remote control until the stations start to change. Then release the button.

Notes:

- **TUNED** appears on the display when you tune to a strong station.
- **STEREO** appears on the display when FM broadcasts are received in stereo and the receiver is not set to FM mono.

Memory Tuning

Memory tuning lets you instantly tune to a stored frequency. You can store up to 30 AM or FM frequencies in the receiver's memory.

Follow these steps to store a station in a memory location.

1. Press **TUNER**. Then press **FM/AM** to select the desired band.
2. Using either manual or automatic tuning, select the frequency you want to store.

If desired, press **FM MONO** for FM monaural sound (see "Using FM Mono" on Page 17). This setting is stored in the memory.

3. Press **MEMORY**. **MEMORY** appears for 5 seconds.
4. While **MEMORY** is on the display, turn the multi-jog control to select the memory number you want, then press **ENTER** to store the frequency in memory.

The frequency and memory number flash, then light steadily.

To tune to a stored frequency, press **SELECT** so **ST** appears on the **JOG MODE** display, then turn the multi-jog control. You can use **STATION -/+** on the remote control to move to the next lower or higher memory. See "Using the Remote Control" on Page 22.

Notes:

- If you store a frequency in a memory that already contains a frequency, you replace the previous frequency.
- If your receiver is disconnected from AC power for several days, it loses all the stored frequencies.

Using FM Mono

To receive FM stations in stereo, press **FM MONO** until **MONO** disappears from the display. **STEREO** appears on the display when you receive an FM broadcast in stereo.

You can improve the reception of weak FM stations by pressing **FM MONO** until **MONO** appears. This reduces noise while you listen to a weak FM station, but you get monaural instead of stereo sound.

Turning Off the Display

You can turn the display off so it does not bother you in a darkened room. Press **DISPLAY OFF**. Only **DISPLAY OFF** appears on the display.

Press **DISPLAY OFF** again or press any button to restore the display.

Using Sleep (Remote Control Only)

The sleep function lets you set the receiver to turn off after 90, 60, or 30 minutes. To start the timer, set **AUDIO/VCR** to **AUDIO**. Then repeatedly press **SLEEP** until the desired turn-off time appears. To cancel the timer, repeatedly press **SLEEP** until the sleep time disappears from the display.

Cassette Deck/VCR Features

You can connect two cassette decks to the receiver. Selecting either **VCR/TAPE 1** or **TAPE 2 MONITOR** lets you hear the playback from the cassette deck you connected to the receiver's corresponding (**VCR/TAPE 1**, **TAPE 2 MONITOR**) jacks.

Using the VCR/TAPE 1 Button

Press **VCR/TAPE 1**. **VCR** appears on the display. You hear the playback from the cassette deck or VCR you connected to the receiver's **VCR/TAPE 1** jacks.

Using the TAPE 2 MONITOR Button

Press **TAPE 2 MONITOR**. **TAPE 2** appears on the display along with the last program source you selected. You can hear playback or monitor a recording from the cassette deck you connected to the receiver's **TAPE 2 MONITOR** jacks.

The **TAPE 2 MONITOR REC** jacks continue to output the previously selected source when you press **TAPE 2 MONITOR**.

To return to the previous source, press **TAPE 2 MONITOR** again so **TAPE 2** disappears.

Notes:

- If you press **TAPE 2 MONITOR** when the cassette deck is neither playing nor recording, the receiver mutes the current audio source. To hear the audio source, press **TAPE 2 MONITOR** until **TAPE 2** disappears from the display.
- Do not press **TAPE 2 MONITOR** while you are recording on the deck connected to **TAPE 2 MONITOR REC**. If you do, the recording is interrupted for about 1 second.

Recording a Program Source

The receiver sends the audio program source you select—**VCR/TAPE 1**, **TAPE 2 MONITOR**, **LD**, **CD**, **TUNER**, **PHONO**—to the **VCR/TAPE 1 OUT** (audio) and **TAPE 2 MONITOR REC** jacks.

The **VOLUME** control does not affect the level of the signal going to the tape decks.

Dubbing a Cassette Tape

You can copy, or dub, a cassette tape from one cassette deck to another.

You can use either deck as the playback or recording deck. However, if you want to monitor the cassette deck during dubbing, use the deck connected to the **VCR/TAPE 1** jacks as the source, and the deck you connected to the **TAPE 2** jacks as the recording deck. Then press **TAPE 2 MONITOR** until **TAPE 2** appears on the display. See "Using the TAPE 2 MONITOR Button."

Playing and Recording Video Tapes

You can connect two video sources to the receiver. If you connect a VCR to the **VCR/TAPE 1** audio and video jacks, you can copy video cassette tapes from one VCR to another and monitor the dubbing process.

Playing a Video Cassette Tape

To play a video tape, load the tape into the VCR connected to either **VCR/TAPE 1** or **LD**. Press the button (**VCR/TAPE 1** or **LD**) that corresponds to the jack the VCR is connected to. **VCR** or **LD** appears on the display. Follow the VCR's instructions to begin playback. If you connected a monitor to the receiver's **TO MONITOR TV** jack, you can view the program on that monitor.

Copying a Video Cassette Tape

Follow these steps to copy a video tape from one VCR to another.

1. Load the tape you want to copy into a VCR connected to **LD**.
2. Load a blank tape (or one you want to record over) in the VCR connected to the **VCR/TAPE 1** jacks.
3. Press **LD**.
4. Begin recording and playback on the VCRs.

Using Advanced Sound Options

Your receiver has four special sound options: Dolby Pro-Logic Surround, Dolby 3CH Logic, Studio-Effect Surround, and Simulated Surround. These special options enhance a program source.

Notes:

- To get the full benefit from programs encoded with Dolby Surround Sound, you need a stereo VCR.
- Dolby Surround does not operate correctly if the signal passes through a graphic equalizer. If you connected an equalizer to the **TAPE 2 MONITOR** jacks, do not select **TAPE 2 MONITOR** when you listen to Dolby Surround signals.

To activate Dolby Pro-Logic Surround or Dolby 3CH Logic, press its button. For studio effect, simulated surround, or arena effect, press **SFC MODE** until the desired option appears on the display. On the remote control, press **3CH LOGIC** to select Dolby 3CH Logic Sound and use **SURR MODE** for other sound options.

Dolby Pro-Logic Surround

Dolby Pro-Logic Surround puts you in the middle of the action. The center- and rear-channel speakers add incredible realism by directing the sound to the appropriate speakers, making you feel like you are really there. You can find hundreds of movies, television shows, and compact discs produced with Dolby Surround.

Dolby 3CH Logic

Dolby 3CH Logic produces a more spacious sound field than is possible with ordinary stereo playback by combining the front and rear speaker sounds. Select this mode when you play a Dolby Surround Sound program and do not have rear speakers. The rear channel's sound is sent to the front left and right speakers.

Studio Effect

Studio Effect gives the effect of listening in a recording studio. The front speakers provide normal stereo, and the rear speakers provide a subtly reverberated sound. Select this mode when you listen to sources not encoded with Dolby Surround.

Simulated Surround

Simulated Surround simulates a surround effect when you listen to a monaural (mono) source.

Sound Mode Adjustments (Remote Control Only)

Notes:

- If you do not use a center speaker, the monaural signals are only reproduced if you select PHANTOM.
- You cannot select PHANTOM in the Dolby 3CH Logic sound mode.

Center Mode Setting

The center mode setting affects the center channel's bass signals. It operates only when you select the Dolby Pro-Logic Surround or Dolby 3CH Logic mode. Slide **AUDIO•VCR** on the remote control to **AUDIO**. Each time you press **CENTER MODE** on the remote control, the setting changes, and the receiver's corresponding indicator lights: **NORMAL - WIDE - PHANTOM** for Dolby Pro-Logic Surround; **NORMAL - WIDE** for Dolby 3CH Logic.

NORMAL—Select this mode if you use a small center speaker. The front left and right speakers play the center-channel bass sounds.

WIDE—Select this mode if you use a medium or large center speaker. The center speaker plays the center-channel bass sounds.

PHANTOM—Select this mode if you have no center speaker. All center-channel sound comes from the front left and right speakers.

Test Tone

The test tone feature provides a test tone that lets you balance the signal levels between all your speakers. See “Center Level” and “Rear Level.”

To activate the test tone, select one of the surround sound modes and set **AUDIO/VCR** on the remote to **VCR**. Then press **TEST TONE**. The receiver sounds a 2-second tone from the front left, center, front right, and rear speakers, in sequence. The center test tone sounds only when you select the Dolby Pro-Logic Surround or Dolby 3 CH Logic sound mode.

In the Dolby 3CH Logic sound mode, the receiver sounds a 2-second tone from the left, center, and right speakers, in sequence.

Press **TEST TONE** again to turn off this feature.

Center Level

Slide **AUDIO•VCR** to **AUDIO**. Then press – **CENTER +** to adjust the center speaker sound level while in the Dolby Pro-Logic Surround or Dolby 3CH Logic mode.

Rear Level

Slide **AUDIO•VCR** to **VCR**. Then press – **REAR +** to set the rear speakers' sound level while in the Dolby Pro-Logic Surround or Simulated Surround mode.

Delay Time

In the Simulated Surround and Dolby Pro-Logic Surround modes, the receiver slightly delays the sound going to the rear speakers. You can change the delay time from 16 to 30 milliseconds (ms) in 2 ms steps. Adjust this for the best surround effect.

Slide **AUDIO•VCR** to **VCR**. Then press and hold **DELAY TIME** to change the delay time. The receiver displays the selected time.

Notes:

- Use the **VOLUME** control to adjust the overall sound level.
- Set the center mode to a selection other than PHANTOM before adjusting the center level.

Notes:

- For Dolby Pro-Logic Surround, the delay is preset to 20 mS.
- The delay time does not affect the Studio Effect mode.

Using the Remote Control

The remote control works up to a distance of about 23 feet, and within a 30-degree angle on either side of the receiver. Point the control at the receiver's front panel and press the desired button(s).

Many buttons on the remote control work the same as buttons on the receiver's front panel. Use these buttons exactly as you would use the corresponding buttons on the receiver.

AUDIO/VCR Switch

The remote control can also control other compatible audio/video components when you connect them to the receiver's **CONTROL OUT** jack. Set the switch to **AUDIO** to control audio components such as CD players or cassette decks. Set the switch to **VCR** to control video components such as a VCR.

When you set the switch to **VCR**, dual-function buttons control the function marked in gold next to the button. For example, the button marked **CENTER MODE** and **TEST TONE** operates as the center mode adjust when you set the switch to **AUDIO** and as the test tone function when you set the switch to **VCR**.

Receiver/Amplifier Section

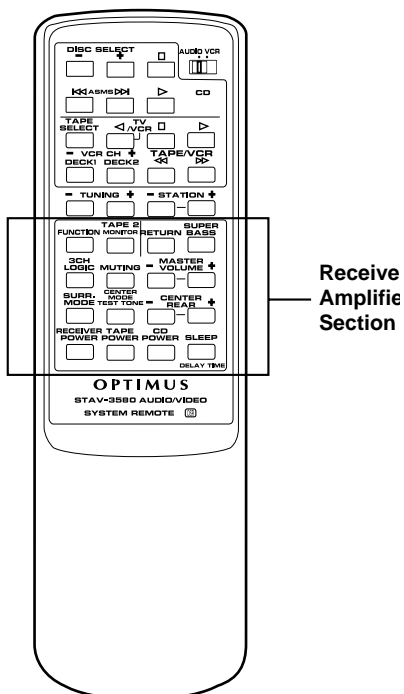

FUNCTION	Selects a program source (VCR/Tape 1, LD, CD, tuner, or phono). Repeatedly press FUNCTION until the display shows your desired program source. See Page 14.
- MASTER VOLUME +	Adjusts the system's volume. See Page 14.
CENTER MODE	Selects among the three center mode settings with AUDIO/VCR set to AUDIO . See Page 21.
- CENTER +	Controls the relative volume of the center speaker with AUDIO/VCR set to AUDIO . See Page 21.
- REAR +	Controls the relative volume of the rear speakers with AUDIO/VCR set to VCR . See Page 21.
TEST TONE	Sounds test tones from each speaker with AUDIO/VCR set to VCR . See Page 21.
DELAY TIME	Sets the rear-channel delay for Dolby Pro-Logic Surround and Simulated Surround programs with AUDIO/VCR set to VCR . See Page 21.
SURR MODE	Selects between Dolby Pro-Logic Surround or Simulated Surround sound. See Page 20.
SLEEP	Sets the receiver to turn off after 90, 60, or 30 minutes with AUDIO/VCR set to AUDIO . To start the timer, repeatedly press SLEEP until the desired turn-off time (90 , 60 , or 30) appears. To cancel the timer, repeatedly press SLEEP until the sleep time disappears from the display. See Page 17.
RECEIVER POWER	Turns the receiver on and off. See Page 14.
RETURN	Returns the receiver to its default settings. See Page 25.
3CH LOGIC	Selects Dolby 3CH Logic. See Page 20.
TAPES 2 MONITOR	Switches the receiver to monitor the source connected to the TAPES 2 MONITOR jacks. See Page 18.

MUTING

Silences the receiver. Press again to restore the sound to its previous level. See Page 15.

- TUNING +

Tunes to radio stations with **AUDIO/VCR** set to **AUDIO**. See Page 16.

Manual Tuning: Press once to select the next higher or lower frequency. Or, press and hold down to rapidly change frequencies.

Automatic Tuning: To search for the next higher or lower station, release + **TUNING** –when the frequency starts to change. The receiver searches up or down the band until it finds a strong station.

- STATION +

Press to move the next higher or lower memory location with **AUDIO/VCR** set to **AUDIO**. See Page 16.

CD Player Section

Note: You must connect the CD player both to your receiver's **CONTROL OUT** jacks and audio jacks for these functions to work.

CD POWER

Turns the CD player on and off (only for CD players having the **CONTROL IN/OUT** feature).

◀◀ and ▶▶

Returns to the beginning of the current track or advances to the next track.

- DISC SELECT +

Selects discs in a multi-play CD changer.

Note: **DISC SELECT** does not work with all CD players.

▶

Plays the CD.

■

Stops playback.

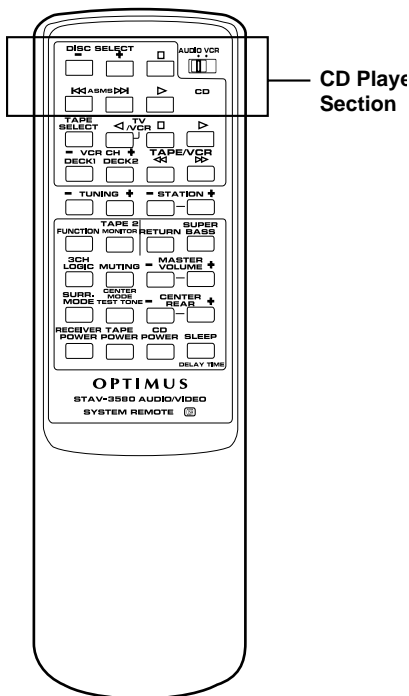

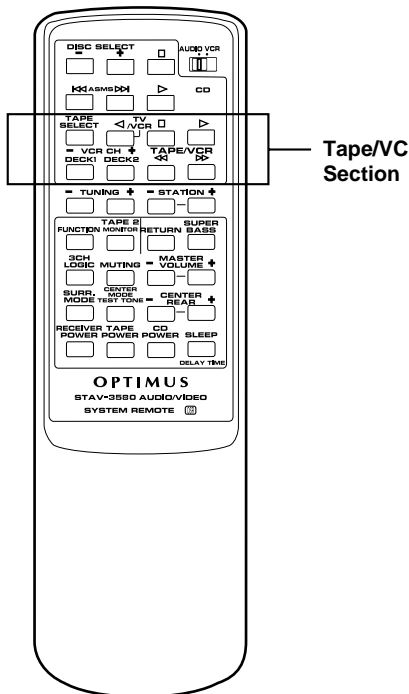

Tape/VCR Section

Before operation:

- Set **AUDIO/VCR** to **AUDIO** for a cassette deck or to **VCR** for a VCR.
- For a cassette deck, select **TAPE 2 MONITOR** or **VCR/TAPE 1**.
- For a dual cassette deck, select **DECK 1** or **DECK 2**. If you use a single cassette deck, press **DECK 2**.
- You must connect the tape deck both to your receiver's **CONTROL OUT** and audio jacks for these functions to work.

- ▶ Press to start normal play.
- ◀ Press to play the reverse side of an auto-reverse cassette deck.
- || Press to cancel the current function.
- ◀◀ and ▶▶ For a cassette deck, lets you quickly locate and play the beginning of recorded material during play.
When the tape is stopped, lets you rapidly search forward or backward to locate a specific section of the tape.
For a VCR, lets you rapidly view a tape either forward or backward.
- DECK 1/DECK 2** Selects Deck 1 or Deck 2 when you use a dual cassette deck with **AUDIO/VCR** set to **AUDIO**.
- TAPE POWER** Turns on the connected VCR with **AUDIO/VCR** set to **VCR**; turns on the cassette deck with **AUDIO/VCR** set to **AUDIO**.
Note: **TAPE POWER** does not work with all Optimus Professional Series cassette decks.
- VCR CH +** Moves to the next higher or lower channel with **AUDIO/VCR** set to **VCR**.
- TV/VCR** Selects between normal TV viewing and VCR input with **AUDIO/VCR** set to **VCR**.
- TAPE SELECT** Selects cassette 1 to 6 for a multi-cassette changer.

Troubleshooting

If the receiver is not working as it should, the following suggestions might help. If you follow the suggestions in this chart and the receiver still does not work properly, contact your local RadioShack store for assistance.

Problem	Cause	Solution
Power does not turn on.	<ul style="list-style-type: none"> • Power cord is disconnected. • Protection circuit is activated. 	<ul style="list-style-type: none"> • Plug in the power cord. • Unplug the power cord, then plug it in again.
The receiver does not respond to button presses.	<ul style="list-style-type: none"> • Static discharge has affected control. 	<ul style="list-style-type: none"> • Unplug the power cord, then plug it in again. (If static electricity is a problem, try to use the remote control as much as possible.)
No sound.	<ul style="list-style-type: none"> • Incorrect connections. • The mute function is activated. • The volume is turned down. • Speaker wires are disconnected. • Neither set of speakers is selected. 	<ul style="list-style-type: none"> • Check and correct the connections. • Press MUTING. • Turn up the volume. • Connect the speaker wires. • Press in SPEAKERS A or B.
No picture when you select a video source.	<ul style="list-style-type: none"> • The selected video source is not set correctly. • Incorrect connections. 	<ul style="list-style-type: none"> • Correct the problem with the selected video source. • Correct the connections.
High noise level.	<ul style="list-style-type: none"> • Station not correctly tuned. • Antenna not connected. • FM antenna still coiled or is not pointing in the correct direction. • AM loop antenna not pointing in the correct direction. • Noise is coming from another electrical appliance. 	<ul style="list-style-type: none"> • Tune to a stronger station. • Connect the antenna. • Stretch both ends of the antenna taut and reposition the antenna. • Adjust the AM loop antenna. • Try using an AC line noise filter to reduce the noise.
Tuning does not automatically stop when searching for FM stations.	<ul style="list-style-type: none"> • Stations are too weak. 	<ul style="list-style-type: none"> • Use a better antenna.
Cannot make copies of video tapes.	<ul style="list-style-type: none"> • Tapes are protected by a copy restriction method. • Video connections are incorrect. 	<ul style="list-style-type: none"> • You cannot make a good copy. • Check and correct the connections.
Remote does not control cassette deck or CD player.	<ul style="list-style-type: none"> • Cassette deck or CD player not compatible. • Control cable is not plugged in. • Audio cables are not plugged in. 	<ul style="list-style-type: none"> • This feature only works with Optimus Professional Series components. • Properly connect the control cable. • Properly connect the audio cables.

Returning Controls to Factory Defaults

Press **RETURN** to return the controls to the following settings.

Tape 2 Monitor	Off
Source	TUNER
Speakers A	On
Band	FM or AM (Set to the last-tuned frequency. If the receiver cannot receive the frequency, it starts searching for the next strong station.)
Surround Mode	Off
Muting	Off
Super Bass	Off

Care and Maintenance

Your STAV-3580 Digital Synthesized A/V Surround Receiver is an example of superior design and craftsmanship. The following suggestions will help you care for the receiver so you can enjoy it for years.



Keep the receiver dry. If it gets wet, wipe it dry immediately. Liquids can contain minerals that can corrode the electronic circuits.



Handle the receiver gently and carefully. Dropping it can damage its circuit boards and can cause the receiver to work improperly.



Use and store the receiver only in normal temperature environments. Temperature extremes can shorten the life of electronic devices, damage batteries, and distort or melt plastic parts.



Keep the receiver away from dust and dirt, which can cause premature wear of parts.



Wipe the receiver with a damp cloth occasionally to keep it looking new. Do not use harsh chemicals, cleaning solvents, or strong detergents to clean the receiver.



Use only fresh batteries of the recommended size and type in the remote control. Always remove old or weak batteries. They can leak chemicals that can destroy electronic circuits.

Modifying or tampering with your receiver's internal components can cause a malfunction and might invalidate the receiver's warranty and void your FCC authorization to operate it. If the receiver is not operating as it should, take it to your local RadioShack store for assistance.

The FCC Wants You to Know

Your receiver might cause radio or TV interference even when it is operating properly. To determine whether your receiver is causing the interference, turn off your receiver. If the interference goes away, your receiver is causing it. Try to eliminate the interference by:

- Moving your radio or TV away from the receiver
- Connecting your receiver to an outlet that is on a different electrical circuit from the radio or TV
- Contacting your local RadioShack store for help

If you cannot eliminate the interference, the FCC requires that you stop using your receiver.

Specifications

Amplifier

Front Channel Average Power Output	110 Watts per Channel into 8 Ohms From 20 to 20,000 Hz, With No More than 0.09% Total Harmonic Distortion Measured Pursuant to the Federal Trade Commission's Trade Regulation Rule on Amplifier Output Power Claims
Front Channel Surround Power Output	110 Watts per Channel
Center Channel Surround Power Output	110 Watts
Continuous Rear Surround Power Output	110 Watts per Channel (1 kHz, 0.8% THD, 8 Ohms)
Dynamic Power Output (2 Ohms/4 Ohms/8 Ohms)	300 Watts/250 Watts/150 Watts
Input Sensitivity/Impedance	
Phono	2.8 mV/47 kOhms
CD, LD, VCR/TAPE 1, Tape 2 Monitor	200 mV/47 kOhms
Phono Overload Level (0.1% THD, 1 kHz)	100 mV
Frequency Response	
Phono	20 Hz to 20,000 Hz \pm 0.3 dB
CD, LD, VCR/TAPE 1, TAPE 2 Monitor	5 Hz to 100,000 Hz +0/-3 dB
Output Level/Impedance	
VCR/TAPE 1 REC, Tape 2 Monitor REC	200 mV/2.2 kOhms
Tone Controls	
Bass	\pm 8 dB (150 Hz)
Treble	\pm 8 dB (10 kHz)
Super Bass	+8 dB (80 Hz)
Signal-to-Noise Ratio (IHF, Short Circuited, A Network)	
Phono	76 dB
CD, LD, VCR/TAPE 1, Tape 2 Monitor	97 dB
Signal-to-Noise Ratio (EIA, at 1 Watt, 1 kHz)	
Phono	77 dB
CD, LD, VCR/TAPE 1, Tape 2 Monitor	80 dB

Video Section

Input Sensitivity/Impedance VCR/TAPE 1, LD	1 Volt Peak-to-Peak/75 Ohms
Output Level/Impedance VCR/TAPE 1, Monitor	1 Volt Peak-to-Peak/75 Ohms
Frequency Response VCR /TAPE 1, LD Monitor	5 Hz to 7MHz +0/-3 dB
Signal-to-Noise Ratio	55 dB
Crosstalk	55 dB

Specifications

FM Tuner

Frequency Range	87.5 to 108 MHz
Usable Sensitivity	Mono: 11.2 dBf, IHF (1.0 μ V/75 Ohms)
50 dB Quieting Sensitivity	
Mono	16.8 dBf (1.9 μ V/75 Ohms)
Stereo	38.6 dBf (23.3 μ V/75 Ohms)
Signal-to-Noise Ratio	
Mono	73 dB (at 85 dBf)
Stereo	70 dB (at 85 dBf)
Distortion Stereo	0.5% (1 kHz)
Alternate Channel Selectivity	60 dB (400 kHz)
Stereo Separation	40 dB (1 kHz)
Frequency Response	30 Hz to 15 kHz (\pm 1 dB)
Antenna Input	75 Ohms Unbalanced

AM Tuner

Frequency Range	530 to 1700 kHz
Sensitivity (IHF, Loop Antenna)	350 μ V/m
Selectivity	25 dB
Signal-to-Noise Ratio	50 dB

General

Power Requirements	120 Volts AC, 60 Hz
Power Consumption	340 Watts, 500 VA (UL)
AC Outlet Ratings Switched	Total 100 Watts (0.8 Amps) Maximum
Dimensions (HWD)	6 ¹ / ₈ × 16 ⁹ / ₁₆ × 11 ¹ / ₁₆ Inches (155 × 420 × 307 mm)
Weight	17 lbs, 10 oz (8 kg)

Specifications are typical; individual units might vary. Specifications are subject to change and improvement without notice.

Index to Features by Control Name

This table lists the control and indicator names found on the front of your receiver, along with the page number where the control or indicator is discussed. To find a description for the buttons on the remote control, see "Using the Remote Control" on Page 22.

Control	Page
BALANCE	15
BASS	14
CD	14
DISPLAY OFF	17
FM MONO	17
FM/AM	16
LD	14
MEMORY	16
MULTI-JOG	16
NORMAL	21
PHANTOM	21
PHONES	15
PHONO	14
POWER	14
RETURN	25
SELECT	16
SFC MODE	20
SPEAKERS A and B	14
SUPER BASS	14
TAPE 2 MONITOR	14, 18
TREBLE	14
TUNER	15
TUNING	23
VCR/TAPE 1	14, 18
VOLUME	14
WIDE	21

RadioShack Limited Warranty

This product is warranted against defects for 2 years from date of purchase from RadioShack company-owned stores and authorized RadioShack franchisees and dealers. Within this period, we will repair it without charge for parts and labor. Simply **bring your RadioShack sales slip** as proof of purchase date to any RadioShack store. Warranty does not cover transportation costs. Nor does it cover a product subjected to misuse or accidental damage.

EXCEPT AS PROVIDED HEREIN, RadioShack MAKES NO EXPRESS WARRANTIES AND ANY IMPLIED WARRANTIES ARE LIMITED IN DURATION TO THE DURATION OF THE WRITTEN LIMITED WARRANTIES CONTAINED HEREIN. Some states do not permit limitation or exclusion of implied warranties; therefore, the aforesaid limitation(s) or exclusion(s) may not apply to the purchaser.

This warranty gives you specific legal rights and you may also have other rights which vary from state to state.

We Service What We Sell

10/95

RadioShack
A Division of Tandy Corporation
Fort Worth, Texas 76102